

## Type 200 Series Welded or Bonded Diaphragm Seal



TYPE 200 SHOWN

*When isolation of the process from an instrument is required, Ashcroft offers a comprehensive line of diaphragm seals. Seal types include threaded, flanged, in-line threaded, in-line flanged, in-line socket weld, in-line butt weld, saddle and sanitary seals. Also available is a complete offering of isolation or iso-rings and isolation or iso-spools.*

### APPLICATIONS

- Elevated process temperatures
- Corrosive service
- Isolation of the process for safety
- Suspended solids in the process
- Sanitary connections
- Replacement of process dead leg
- Ease of cleaning between batches

### FEATURES

- A metal diaphragm is welded to the top housing. Elastomeric diaphragms are bonded to the top housing. Either provides a double positive seal.
- A fill/bleed connection is standard, which permits filling the seal and instrument simultaneously after evacuation and allows the fill to flow into the completed unit.
- A thin Teflon PTFE gasket between the diaphragm and bottom housing ensures a leak-tight corrosion resistant seal even at high pressure.
- Top housing and pressure instrument are removable.
- Continuous-duty design will prevent loss of process fluid if pressure instrument is removed or fails.

### SPECIFICATIONS

**Model Number:** Type 200, 201, 202, 203, 204, 205, 206, 207, 208

**Process Connection Size:** See Table A  
**Instrument Connection Size:** 1/4", 1/2" NPT

**Diaphragm Material:** See Table B

**Bottom Housing Materials:** See Table C

**Filling Fluid:** See Table E

### OPTIONS

316 stainless steel top housing

Stainless steel clamp rings and flanged ring – includes 300 stainless steel clamping bolts (1500 psi max)

300 series stainless steel clamping bolts (max pres is 1500 psi)

Pipe plugs for flushing connections – pipe plugs are available in the same materials as bottom housings per Table C

5000 psi pressure rating Threaded inlet and metal diaphragm only

Welded instrument to diaphragm seal

Dual flushing connections (1/2" NPT) (Limited to 2" thru 3" flanged seals)

Ring joint (Flanged seal only)

Flat face (Flanged seal only)

Clean for gaseous oxygen or strong oxidizing agent applications.

**Code**

**YT**

**SE**

**SB**

**PU**

**HP**

**DU**

**DB**

**RJ**

**FF**

**6B**

### HOW TO ORDER:

1. From Table A...select TYPE NUMBER based on process connection, process connection size and diaphragm type/construction. (e.g., Threaded/1"capsule-code-10-200)
2. From Table B...select DIAPHRAGM MATERIAL. (e.g., 316L stainless steel-code S)
3. From Table C...select BOTTOM HOUSING MATERIAL. (e.g., 316 stainless steel-code S)
4. From Table D...select INSTRUMENT CONNECTION size. (e.g., 1/4" NPT-code 02T)
5. From Table E...select FILLING FLUID, if diaphragm seal will be attached to instrument. (e.g., Glycerin-code CG)

Typical Code: 10-200SS-02T-CG

## Type 200 Series Welded or Bonded Diaphragm Seal

### TYPE 200 SERIES WELDED OR BONDED SEAL TYPES

#### Type 200 – Threaded

¼, ½, ¾, 1 NPT



#### Type 201 – Threaded with flushing connection

¼, ½, ¾, 1 NPT



#### Type 202 – Raised Face Flanged

½, ¾, 1, 1½, 2, 3"



#### Type 203 – Raised Face Flanged with flushing connection

½, ¾, 1, 1½, 2, 3" (raised face only)  
1 piece with flushing connection



#### Type 204 – In-line Threaded

¼, ½, ¾, 1 NPT



#### Type 205 – Saddle

3, 4" pipe only



#### Type 206 – In-line Flanged

½, ¾, 1, 1½, 2, 3, 4, 6, 8"



#### Type 207 – In-line Socket Weld

½, ¾, 1, 1½, 2"



#### Type 208 – In-line Butt Weld

¼, ½, ¾, 1, 1½, 2"



**Table A – Process Connection/Type Number**

Process Connection	Process Connection Size/Code—Inches											Type Number
	Size	¼	½	¾	1	1½	2	3	4	6	8	Code
Threaded—female NPT	Code	25	50	75	10	15	20	30	40	60	80	200
Threaded—female NPT (with flushing conn.)		*	*	*	*	*						201
Flanged <sup>(1)</sup>			*	*	*	*	*	*				202
Flanged (with flushing conn.)			*	*	*	*	*	*				203
In-line—threaded NPT		*	*	*	*	*						204
Saddle								*	AND LARGER			205
In-line—butt weld		*	*	*	*	*	*	*				208
In-line—flanged <sup>(2)</sup>		*	*	*	*	*	*	*	*	*	*	206
In-line—socket weld		*	*	*	*	*	*	*				207

Pressure Ratings—All 2500 psi except flanged seals are per ASME B 16.5, temperature limit determined by diaphragm, bottom housing and/or filling fluid.

**Table B – Diaphragm Material**

Material	Code
316L stainless steel	S
304 stainless steel	C
Monel 400	P
Nickel	N
Carpenter 20	D
Tantalum	U
Hastelloy B	G
Hastelloy C 22 <sup>(6)</sup>	J
Hastelloy C 276 <sup>(6)</sup>	H
Teflon <sup>(4)</sup>	T
Viton <sup>(5)</sup>	Y
Kalrez <sup>(12)</sup>	K
Titanium <sup>(14)</sup>	TI

**Table C – Housing Materials**

Material	Code
Steel	B
304L stainless steel	C
316L stainless steel	S
Hastelloy B	G
Hastelloy C 22 <sup>(6)</sup>	J
Hastelloy C 276 <sup>(6)</sup>	H
Carpenter 20	D
Monel "400"	M
Inconel "600"	W
Nickel	N
PVC <sup>(7)(15)</sup>	V
Tantalum clad SS <sup>(6)</sup>	SU
Halar coated SS <sup>(9)</sup>	BH
Teflon flanged steel <sup>(10)</sup>	T
Kynar <sup>(13)(15)</sup>	KY
Titanium	TI

**Table D – Instrument Connection**

Size – NPT	Code
¼	O2T
½	O4T

**Table E – Filling Fluid**

Filling	Service	Connection to Instrument	Temperature Range °F	Code
Glycerin	Pressure	Direct Only	0/400	CG
Silicone	Pressure/Vacuum	Direct or Flexible Line	-40/500	CK
Halocarbon	Pressure/Vacuum in presence of strong oxidizing agent	Direct or Flexible Line	-70/300	CF, DJ
Syltherm	Pressure/Vacuum	Direct or Flexible Line	-40/750	HA

#### Notes:

- (1) 150, 300, 600, 900, 1500 & 2500 class flanges.
- (2) 1" 150 thru 8" 300 class flanges only.
- (3) Metal diaphragms welded; Teflon, Kalrez & Viton diaphragms bonded.
- (4) Temp limits: -40/400°F.
- (5) Max. pressure: 500 psi, Temp. limits: -40/350°F.
- (6) Use on applications where NACE standard MR-01-75 2003 is standard.
- (7) Maximum press./temp. Threaded: 200 psi/74°F, 125 psi/125°F, 80 psi/150°F. Flanged: 75 psi/100°F.
- (8) Type 202 only.
- (9) Temp. Limits: -40/300°F.
- (10) Only available in 1", 1½", & 2" 150 class, Types 202 max. press./temp. - 270 psi and 150°F. Consult factory for conditions beyond these limits.
- (11) Max. pressure: 500 psi, Temp. limits: 30/212°F.
- (12) Maximum pressure/temp.: 200 psi and 180°F.
- (13) Type 200: ¼ or ½ NPT only. Larger sizes offered with solvent weld joint. N/A in 201 or 203 design.
- (14) Includes Titanium top housing.
- (15) Type 200 only available in 1/4 NPT or 1/2 NPT. 3/4" & 1" size available as solvent welded joint only.

# Type 200 Series Welded or Bonded Diaphragm Seal

## DIMENSIONS

### Type 200 – Threaded

¼, ½, ¾, 1 NPT

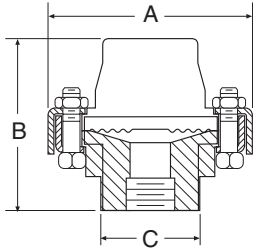

A		B		C	
in	mm	in	mm	in	mm
¾"	(95)	2 7/8"	(73)	1 13/16"	(46)

### Type 201 – Threaded

¼, ½, ¾, 1 NPT (with flushing connection)

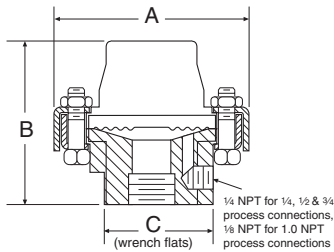

A		B		C	
in	mm	in	mm	in	mm
¾"	(95)	2 7/8"	(73)	1 13/16"	(46)

### Type 202 – Flanged

½, ¾, 1"

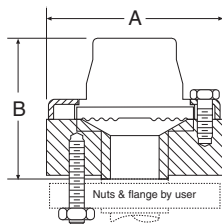

Flange Size		A		B	
Rating #	in	mm	in	mm	mm
150	3 1/2"	(89)	2 15/16"	(75)	
¾"	300 or 600	3 3/4"	(95)	3"	(76)
	900 or 1500	4 3/4"	(121)	3 3/4"	(81)
150	3 7/8"	(98)	2 13/16"	(71)	
¾"	300 or 600	4 5/8"	(117)	3"	(76)
	900 or 1500	5 1/8"	(130)	3 3/4"	(81)

### Type 202 – Flanged 1" (raised face only)

two piece bottom housing, 1 ½, 2, 3" - PVC, Teflon and Kynar

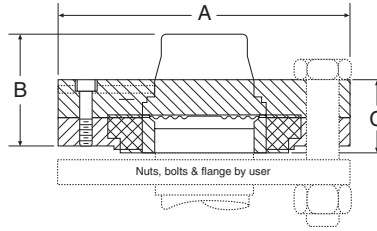

Flange Size		A		B		C	
Rating #	in	mm	in	mm	in	mm	
1 ½"	150	5"	(127)	2 5/16"	(59)	1 13/32"	(39)
2"	150	6"	(152)	2 1/8"	(54)	1 9/16"	(40)

### Type 202 – Flanged (raised face only)

1 ½, 2, 3" one piece bottom housing - all materials except PVC, Teflon and Kynar

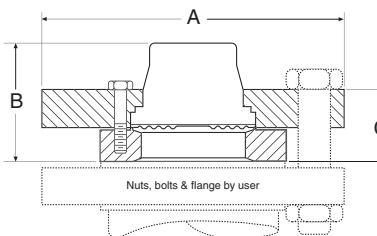

Flange Size		A		B		C	
Rating #	in	mm	in	mm	in	mm	
1 ½"	150	5"	(127)	1 ½"	(38)	1 ½"	(38)
	300 or 600	6 1/4"	(159)	2 3/8"	(61)	1 ½"	(38)
	900 or 1500	7"	(178)	1 ½"	(38)	1 ½"	(38)
2"	150	6"	(152)	1 3/8"	(35)	1 ½"	(38)
	300 or 600	6 1/2"	(165)	1 15/16"	(49)	1 ½"	(38)
	900 or 1500	8 1/2"	(216)	2 1/8"	(54)	1 ½"	(38)
150	7 1/2"	(191)	2"	(51)	1 5/8"	(41)	
3"	300 or 600	8 1/4"	(206)	2 1/4"	(52)	1 7/8"	(47)
	900 or 1500	10 1/2"	(267)	2 11/16"	(68)	3 1/4"	(82)

### Type 203 – Flanged

½, ¾" (with flushing connection)

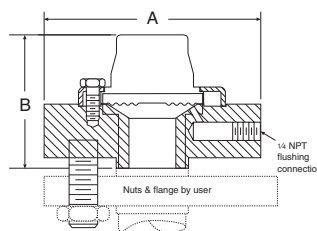

Flange Size		A		B	
Rating #	in	mm	in	mm	mm
150	3 1/2"	(89)	2 15/16"	(75)	
½"	300 or 600	3 3/4"	(95)	3"	(76)
	900 or 1500	4 3/4"	(121)	3 3/4"	(81)
150	3 7/8"	(98)	2 13/16"	(71)	
¾"	300 or 600	4 5/8"	(117)	3"	(76)

### Type 202/203 – Flanged 1" (raised face only)

one piece bottom housing, with and without flushing connection. Class 150, 300, 600

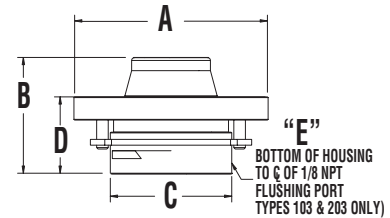

Flange Size		A		B		C	
Rating #	in	mm	in	mm	in	mm	
1	150	4-1/4"	(100)	2-9/16"	(65)	1-23/32"	(69)
	300 or 600	5"	(127)				

Flange Size		D		E	
Rating #	in	mm	in	mm	mm
1	150	1-5/8"	(41)	3/8"	(9)
	300 or 600				

### Type 202/203 – Flanged 1" (raised face only)

one piece bottom housing, with and without flushing connection. Class 900, 1500, 2000

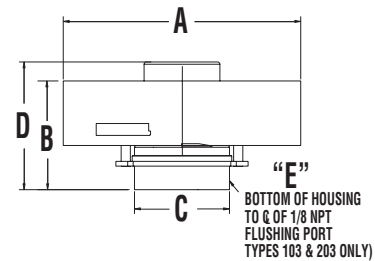

Flange Size		A		B		C	
Rating #	in	mm	in	mm	in	mm	
1	900 or 1500	5-7/8"	(149)	2-7/8"	(73)	2-1/4"	(57)
	2500	6-1/4"	(159)				

Flange Size		D		E	
Rating #	in	mm	in	mm	mm
1	900 or 1500	3-3/8"	(86)	3/8"	(9)
	2500				

## Type 200 Series Welded or Bonded Diaphragm Seal

### DIMENSIONS

**Type 203 – Flanged 1½," 2," 3" (raised face only)**  
one piece bottom housing with flushing connection

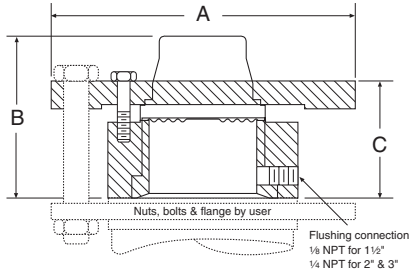

Flange Size	Rating #	A in	A mm	B in	B mm	C in	C mm
150		5	(127)				
1½"	300 or 600	6¼	(159)	3	(76)	2½	(64)
	900 or 1500	7	(178)				
2"	300 or 600	6	(152)	3½	(89)	2¾	(71)
	900 or 1500	8½	(215)				
3"	150	7½	(191)	3¾	(94)	2¾	(71)
	300 or 600	8¼	(210)	3¾	(94)	2¾	(71)
	900	9½	(241)				
	1500	10½	(267)				

**Type 204 – In-Line Threaded**  
¼, ½, ¾, 1 NPT

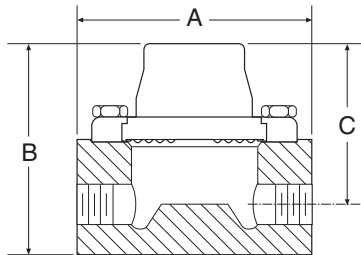

Process Connection	A in	A mm	B in	B mm	C in	C mm
¼ NPT	4	(102)	2½	(64)	2½	(64)
½ NPT			3½	(92)	2¾	(71)
¾ NPT			3¾	(98)	3	(76)
1 NPT			3¾	(98)	3	(76)

**Type 205 – Saddle**  
4" Pipe only

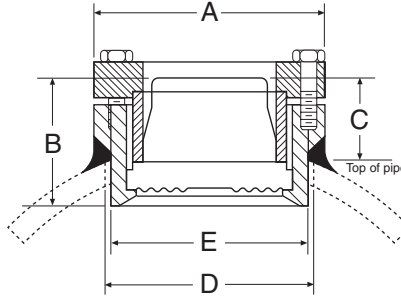

A in	A mm	B in	B mm	C in	C mm	D in	D mm	E in	E mm
3½	(89)	1½	(50)	1¾	(31)	3	(76)	2¾	(71)

**Type 205 – Saddle**  
3" Pipe only

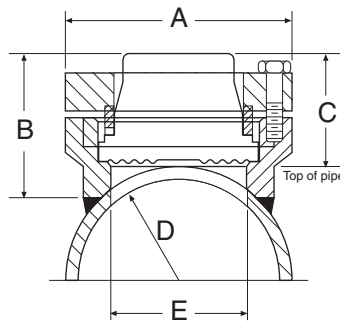

A in	A mm	B in	B mm	C in	C mm	D in	D mm	E in	E mm
3½	(89)	2¼	(57)	1¾	(48)	1¾	(44)	2½	(64)

**Type 206 – In-Line Flanged**  
½, 1, 1½, 2, 3"

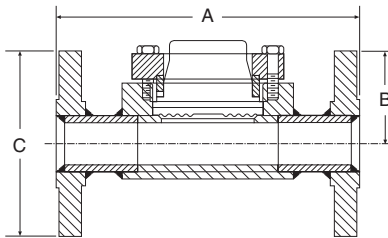

Flange Size	Rating #	A in	A mm	B in	B mm	C in	C mm
½"	150	7	(178)			3½	(89)
	300	7	(178)	2½	(62)	3¾	(98)
1"	150	7	(178)			4¼	(108)
	300	8	(203)	2½	(62)	4¾	(123)
1½"	150	8	(203)			5	(127)
	300	9	(229)	2½	(68)	6½	(155)
2"	150	9	(229)			6	(152)
	300	10	(254)	2½	(75)	6½	(165)
3"	150	11	(279)			7½	(229)
	300	12	(305)	3¾	(92)	8¼	(254)

**Type 206 – In-Line Flanged**  
4," 6," 8"

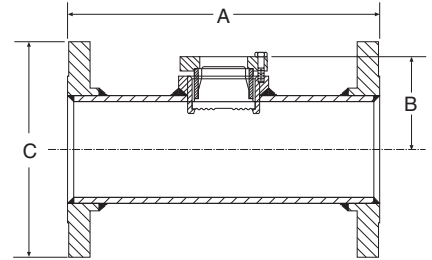

Flange Size	Rating #	A in	A mm	B in	B mm	C in	C mm
4"	150	13	(330)			9	(229)
	300	14	(356)	3¾	(86)	10	(254)
6"	150	16	(406)			11	(279)
	300	17	(432)	4¾	(113)	12½	(318)
8"	150	16	(406)			13½	(343)
				5¾	(138)		

**Type 207 – In-Line Welded**  
¼, ½, ¾, 1, 1½, 2"

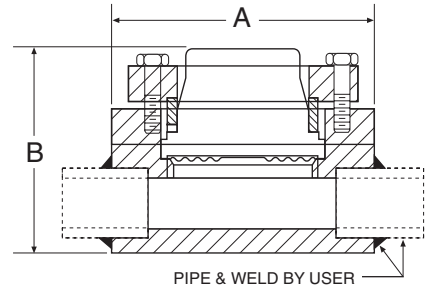

Pipe Size	A in	A mm	B in	B mm
¼"	4	(102)	2½	(64)
½, ¾"			2½	(64)
1"			2½	(63)
1½"			2¾	(69)
2"			2¾	(75)